

## Laparotomy Set (52 Item)



solid

Scalpel handle No. 3, 12,0 cm (1Pc)  
STANDARD

10-200-003 12,0 cm / 4<sup>3</sup>/<sub>4</sub>"



solid

Scalpel Handle No. 4, 12,0 cm (1Pc)  
STANDARD

10-210-004 12,0 cm / 4<sup>3</sup>/<sub>4</sub>"



solid

Scalpel handle no. 7, 16,0 cm (1Pc)  
STANDARD

10-220-007 16 cm / 6<sup>1</sup>/<sub>4</sub>"

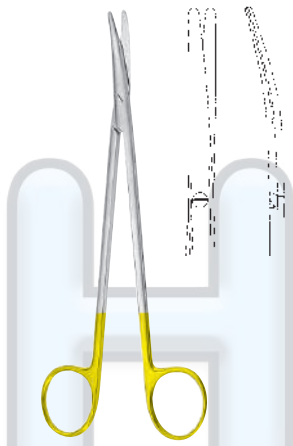

Scissor curved 18,0 cm (1Pc)  
Scissor curved 20,0 cm (1Pc)  
Scissor curved 23,0 cm (1Pc)  
TC-METZENBAUM

12-731-180 18,0 cm / 7"  
12-731-200 20,0 cm / 8"  
12-731-230 23,0 cm / 9"

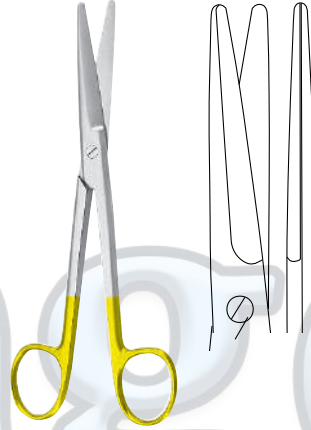

Scissor straight 14,5 cm (2Pcs)  
TC-MAYO

12-710-145 14,5 cm / 5<sup>3</sup>/<sub>4</sub>"

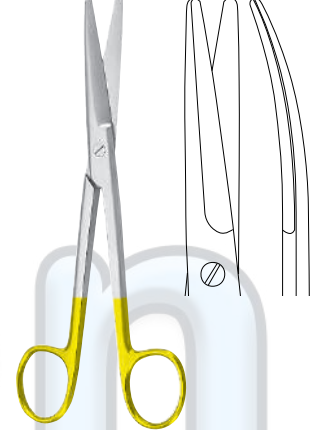

Scissor curved 14,5 cm (2Pcs)  
TC-MAYO

12-711-145 14,5 cm / 5<sup>3</sup>/<sub>4</sub>"

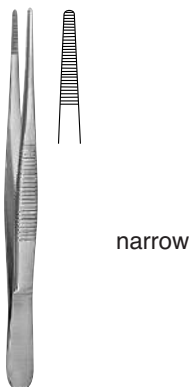

narrow

Dressing forcep narrow 14,5 cm (2Pcs)  
Dressing forcep narrow 20,0 cm (2Pcs)  
STANDARD

13-110-145 14,5 cm / 5<sup>3</sup>/<sub>4</sub>"  
13-110-200 20,0 cm / 8"



1x2

Tissue forcep curved 1x2 teeth  
13,0 cm (1Pc)  
STANDARD

13-241-130 13,0 cm / 5"



1x2

Tissue Forceps 1x2 teeth  
straight 20,0 cm (1Pc)  
STANDARD

13-200-200 20,0 cm / 8"

## Laparotomy Set (52 Item)



Dressing Forceps straight 26,5 cm  
(2Pcs)  
GROSS-MAIER

15-800-265 26,5 cm / 10½"

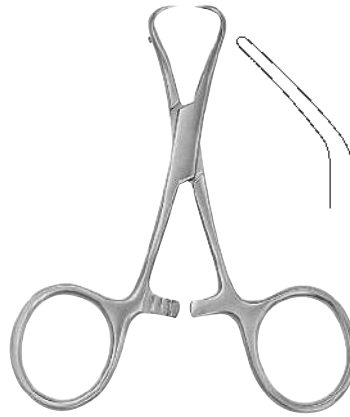

Towel forceps 11,0 cm (6Pcs)  
BACKHAUS

15-711-110 11,0 cm / 4¾"

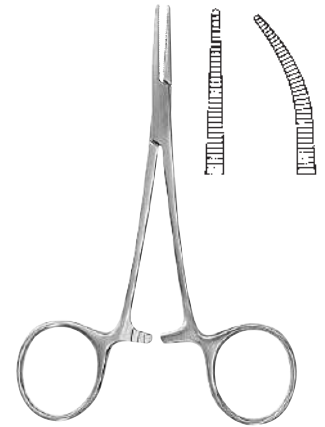

Forceps straight 12,5 cm (6Pcs)  
Forceps curved 12,5 cm (6Pcs)  
HALSTED-MOSQUITO

15-100-125 12,5 cm / 5"  
15-101-125 12,5 cm / 5"

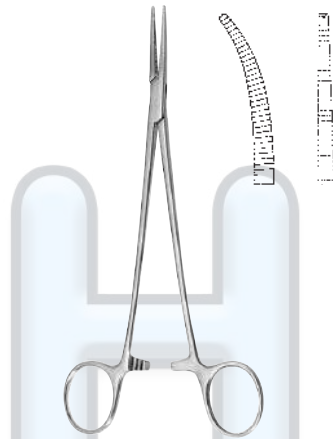

Forceps curved 18,0 cm (2Pcs)  
Forceps straight 1x2 teeth 18,0 cm (2Pcs)  
HALSTED-MOSQUITO

15-101-180 18,0 cm / 7"  
15-102-180 18,0 cm / 7"

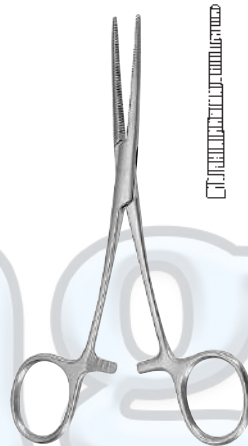

Forceps straight 14,0 cm (2Pcs)  
PEAN-DELICATE

15-250-140 14,0 cm / 5½"

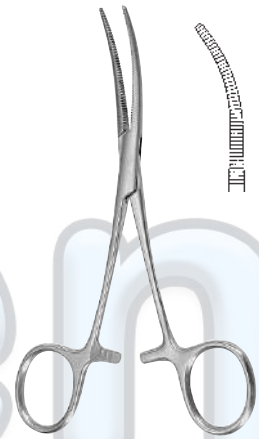

Forceps curved 14,0 cm (2Pcs)  
PEAN-DELICATE

15-251-140 14,0 cm / 5½"



Forceps straight 24,0 cm (1Pc)  
KOCHER-OCHSNER

15-280-240 24,0 cm / 9½"



Forceps straight 24,0 cm (1Pc)  
ROCHESTER-PEAN

15-260-240 24,0 cm / 9½"



Forceps straight 14,0 cm (1Pc)  
KOCHER-OCHSNER

15-280-140 14,0 cm / 5½"

## Laparotomy Set (52 Item)



1x2



Forceps curved 14 cm (1pc)  
**KOCHER-OCHSNER**

**15-281-140** 14,0 cm / 5 1/2"

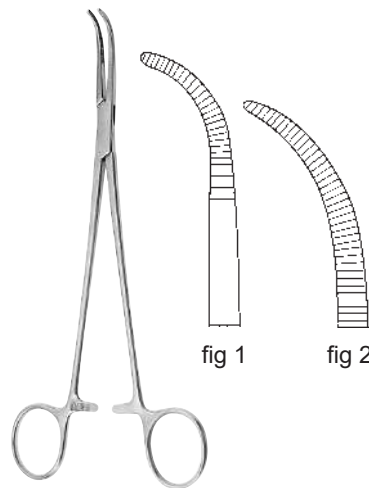
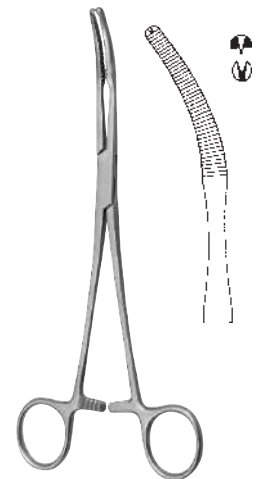

fig 1

fig 2

Forceps 21,0 cm fig.1 (1pc)  
Forceps 21,0 cm fig.2 (1pc)  
**OVERHOLT-GEISSENDOERFER**

**15-495-001 – 15-495-002** 21,0 cm / 8 1/4"



Peritoneal clamp forceps angled  
1x2 teeth 20,0cm (2pcs)  
**MIKULICZ**

**15-647-200** 20,0 cm / 8"



Needle case 7-part with perforated  
lid and bottom 150x95x13 mm (1pc)

**19-070-002** 150x95x13 mm  
perforated lid and bottom

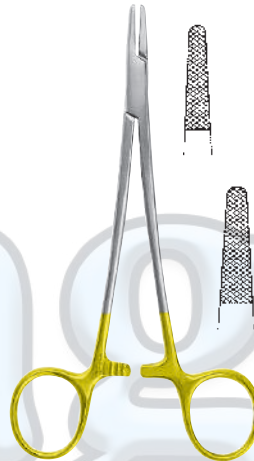

Needleholder 14,0 cm (1pc)  
Needleholder 18,0 cm (1pc)  
Needleholder 20,0 cm (1pc)  
**TC-MAYO-HEGAR**

**19-550-140** 14,0 cm / 5 1/2"  
**19-550-180** 18,0 cm / 7"  
**19-550-200** 20,0 cm / 8"



Needle Holder 27 cm (1pc)  
**WANGENSTEEN**

**19-256-270** 27,0 cm / 10 1/2"

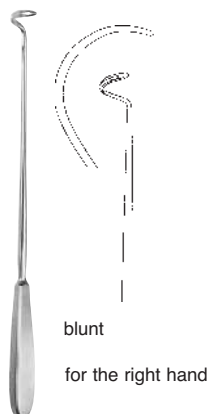

blunt

for the right hand

Ligatur needle blunt curved to left  
f. The right hand 21,0 cm (1pc)  
**DESCHAMPS**

**19-810-210** 21,0 cm / 8 1/4"



Grooved Director 16,0 cm (1pc)  
**NELATON**

**17-073-160** 16,0 cm / 6 1/4"



Probe buttoned 14,5 cm / 2,0 mm  
(1pc)

**17-014-145** 14,5 cm / 5 3/4"

## Laparotomy Set (52 Item)



Fig.1 24x20 mm  
Fig.2 29x26 mm  
Fig.3 33x29 mm



Set, fig. 1-3

Fig.1 30x28 mm  
Fig.2 36x36 mm  
Fig.3 38x43 mm



**Retractor double end set/fig. 1 - 3 (2Set)  
ROUX**

**16-450-000** 17,0 cm / 6<sup>3</sup>/<sub>4</sub>" Fig.1-3

sharp

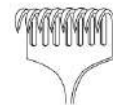

15x40 mm

**Retractor sharp 8 prong 22 cm  
(2pcs)  
KOCHER**

**16-140-008** 22,0 cm / 8<sup>5</sup>/<sub>8</sub>"



**Retractor 26,0 cm / 90x55 mm (2pcs)  
MIKULICZ**

**16-416-260** 26,0 cm / 10<sup>1</sup>/<sub>4</sub>" 90 x 55 mm

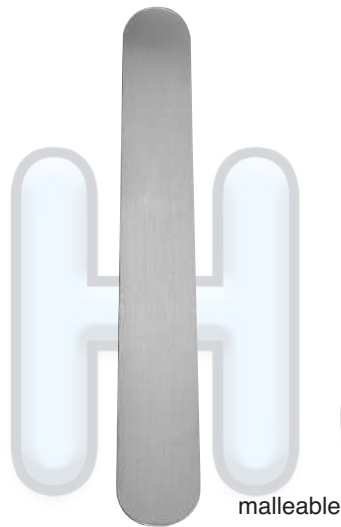

malleable

**Spatulas flexible 28cm / 25/30mm (1pc)  
HABERER**

**16-492-280** 280x25/30 mm

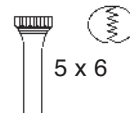
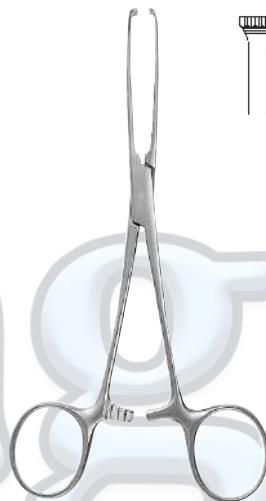

5 x 6

**Intestinal forcep 5x6 teeth, 19,0 cm  
(2pcs)  
ALLIS**

**27-120-190** 19,0 cm / 7<sup>1</sup>/<sub>2</sub>"

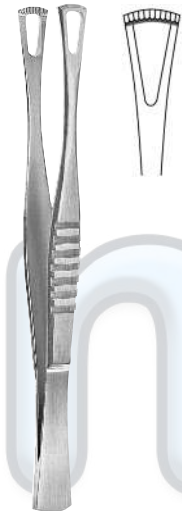

**Tissue forceps 14,0 cm (1pc)  
DUVAL**

**13-402-140** 14,0 cm / 5<sup>1</sup>/<sub>2</sub>"

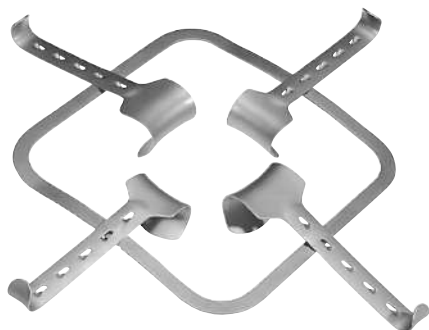

**Abdominal Retractors square Complete  
with 1 frame rigid 240x240mm, 2 hook  
on retractor 40x55mm, 2 hook on  
retractor 50x65mm (1pc)  
KIRSCHNER**

**16-810-000**  
complete

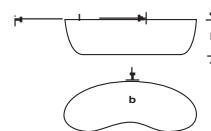

**Kidney bowl 250 x 140 x 40 mm(1pc)**

**85-500-250** 250 x 140 x 40 mm



**Wash bowl ø 330 x 115 mm / 8,00  
litre (1pc)**

**85-340-800** Ø 330 x 115 mm 8,00l



## Laparotomy Set (52 Item)

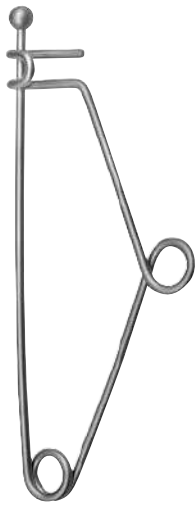

Safety pin 14,0 cm (5pcs)  
MAYO

85-172-140 14,0 cm / 5 1/2"



Instrument Tray  $\pm 350 \times 240 \times 10$  mm (1pc)

85-356-240 350 x 240 x 10 mm

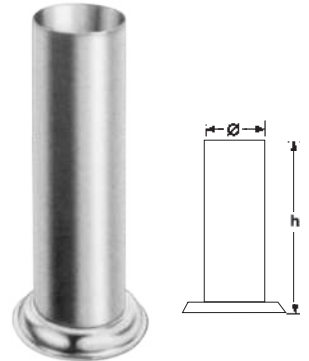

Metal without lid  $\varnothing 100 \times 175$  mm (1pc)

85-374-175  $\varnothing 100 \times 175$  mm

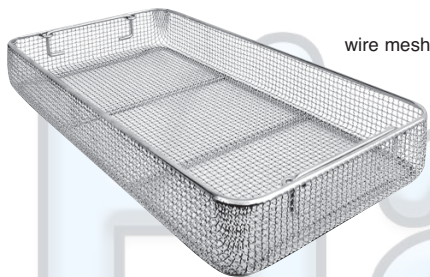

wire mesh

Wire basket standard  
535x 250 x 70 mm (1pc)

95-220-070 540 x 255 x 70 mm



Bottom non perforated

Bottoms non perforated 585x274x138 mm,  
Outside  $\pm 585 \times 278 \times 155$  mm (1pc)

90-070-150 580 x 280 x 150 mm

$\pm 585 \times 278$  mm **ECONOMY**



Lid perforated

**ECONOMY Lid perforated**  
 $\pm 585 \times 278$  mm, green, for 1/1  
Container (1pc)

90-014-580

Aluminium identification tag with slot - engraved



Identification tag Aluminium, silver, Laparotomy  
Set (1pc)

98-220-170 50 x 17 mm

Stainless steel identification tag - engraved



Clamping tag from Stainless Steel, matt, for Wire Baskets,  
engraved, 90x50 mm, Laparotomy Set (1pc)

98-366-050 90 x 50 mm